

## THE EFFECTS OF FINITE LINER ACCELERATION ON SHAPED-CHARGE JET FORMATION

W.J. Flis

*DE Technologies, Inc., 3620 Horizon Drive, King of Prussia, PA, 19406, USA*

The classical theory of shaped-charge jet formation assumes that each liner particle accelerates instantaneously and collapses along a straight path. Actually, the liner accelerates gradually and the collapse path is curved. The effects on jet formation due to these simplifying assumptions are examined. The results of considering finite acceleration and a curved path are shown to include: longer path, forward point of collapse, reduced  $\delta$  and  $\beta$  angles, and reduced jet velocity. Collapse formulas are derived for a liner accelerated at a finite rate along curved and straight paths. Jet properties computed from these formulas are compared with those predicted by the classical theory, and with hydrocode calculations. The results show that the effect of finite acceleration is large, but the effect of path curvature is negligible.

### INTRODUCTION

In the classical Pugh-Eichelberger-Rostoker [1] (P-E-R) theory of shaped-charge formation, each particle of the liner is assumed to be instantaneously accelerated and to collapse along a straight-line path. Eichelberger [2] investigated, qualitatively, the effect of a finite acceleration on the jet properties and concluded that its effect is small. However, since the acceleration is finite, not only the velocity but also the final direction of each liner particle is achieved over a finite period. The result is a collapse path that is curved. This paper addresses this issue in a quantitative manner, based on the empirical, exponential acceleration history proposed by Randers-Pehrson [3] and later adopted by Chou et al. [4].

The collapse path follows a direction that deviates from the normal to the liner by the projection angle  $\delta$ . For the straight path assumed by the classical theory, this angle has a single value, which is computed in the P-E-R theory from the liner's fully accelerated velocity  $V_0$  by the Taylor formula,

$$\sin \delta = \frac{V_0}{2U} \quad (1)$$

where  $U$  is the rate of sweeping of the detonation wave along the liner. However, in actuality, the liner is not instantaneously accelerated to final velocity  $V_0$  nor is its final direction of motion immediately achieved. The result is a curved collapse path.

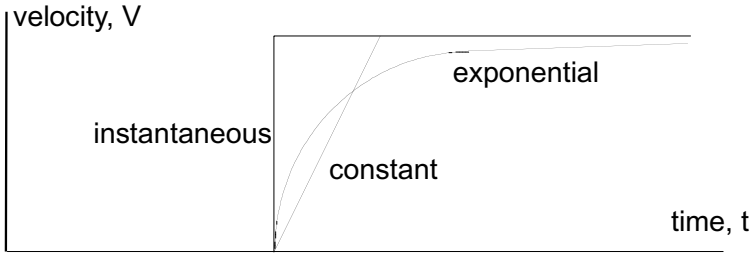

Figure 1. Instantaneous, constant, and exponential acceleration histories.

Following Randers-Pehrson, we assume that the liner is accelerated according to the exponential velocity history shown in Fig. 1,

$$V(t) = V_0 \left[ 1 - \exp \left( - \frac{t - T}{\tau} \right) \right] \tag{2}$$

where  $\tau$  is an empirical constant and  $T$  is the time of arrival of the detonation wave, and therefore onset of motion, at the given point on the liner. Chou et al. and Flis [5] showed that this is a good approximation of the actual velocity history of an explosively accelerated liner. Chou et al. used this velocity history in the unsteady theory of liner projection to derive the unsteady projection-angle formula

$$\delta_0 = \frac{V_0}{2U} - \frac{1}{2}\tau V_0' + \frac{1}{4}\tau^2 V_0'' \tag{3}$$

where the primes denote derivatives along the meridian of the liner.

Now, since the final direction is not immediately achieved, we assume that the sine of the projection angle is always proportional to the velocity, so that

$$\sin \delta(t) = \sin \delta_0 \left[ 1 - \exp \left( - \frac{t - T}{\tau} \right) \right] \tag{4}$$

where  $\delta_0$  is the final theoretical projection angle, given by one of the Taylor formulas, eq. (1) or (3). This assumption is the same as assuming that the classical (steady) Taylor formula (1) holds at each time  $t$ .

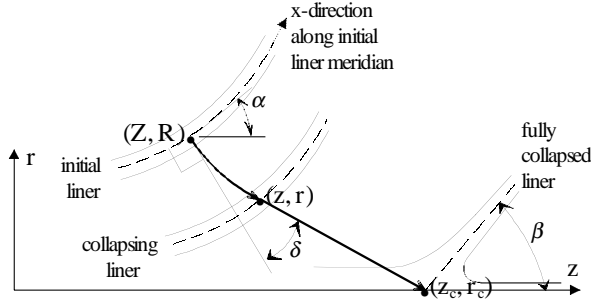

Figure 2. Definition of liner collapse geometry.

The geometrical coordinates are defined in Fig. 2. The conditions for liner collapse may then be derived following the time-dependent formulation of Behrmann [6],

$$r_c = R - \int_T^{t_c} V(t) \cos[\alpha + \delta(t)] dt \tag{5}$$

$$z_c = Z + \int_T^{t_c} V(t) \sin[\alpha + \delta(t)] dt \tag{6}$$

where  $(z_c, r_c)$  is the position and  $t_c$  the time at which the particle fully collapses. Integrating these, with the approximation that  $\delta$  is small (so that  $\cos \delta \sim 1$ ), results in

$$r_c = R - V_0 [F_1(t_c) \cos \alpha - F_2(t_c) \sin \alpha \sin \delta_0] \tag{7}$$

$$z_c = Z + V_0 [F_1(t_c) \sin \alpha + F_2(t_c) \cos \alpha \sin \delta_0] \tag{8}$$

where  $F_1$  and  $F_2$  are explicit functions of time,

$$F_1(t) = \int_T^t \left[ 1 - \exp\left(-\frac{t-T}{\tau}\right) \right] dt = t - T - \tau \left[ 1 - \exp\left(-\frac{t-T}{\tau}\right) \right], t \geq T \tag{9}$$

$$F_2(t) = 2F_1(t) - t + T + \frac{\tau}{2} \left[ 1 - \exp\left(-2\frac{t-T}{\tau}\right) \right], t \geq T \tag{10}$$

The collapse time  $t_c$  is found by solving eq. (7) iteratively, given the initial radial coordinate  $R$  of the liner particle; then eq. (8) gives the axial location of the collapse point. Usually, the collapse radius is taken as zero, although it need not be. Based on these formulas, the  $\beta$  angle may be obtained from the relation

$$\tan \beta = \left. \frac{dr}{dz} \right|_{t=t_c} = \left. \frac{\partial r}{\partial Z} \right|_{t=t_c} / \left. \frac{\partial z}{\partial Z} \right|_{t=t_c} \tag{11}$$

in which the derivatives are

$$\begin{aligned} \frac{\partial r}{\partial Z} = & R' + V_0'(\sin \delta_0 \sin \alpha F_2 - \cos \alpha F_1) + V_0(\sin \alpha \alpha' F_1 - \cos \alpha F_1' + \\ & + \cos \delta_0 \delta_0' \sin \alpha F_2 + \sin \delta_0 \cos \alpha \alpha' F_2 + \sin \delta_0 \sin \alpha F_2') \end{aligned} \tag{12}$$

$$\begin{aligned} \frac{\partial z}{\partial Z} = & 1 + V_0'(\sin \alpha F_1 + \sin \delta_0 \cos \alpha F_2) + V_0(\cos \alpha \alpha' F_1 + \sin \alpha F_1' + \\ & + \cos \delta_0 \delta_0' \cos \alpha F_2 - \sin \delta_0 \sin \alpha \alpha' F_2 + \sin \delta_0 \cos \alpha F_2') \end{aligned} \tag{13}$$

in which primes denote derivatives with respect to initial axial position  $Z$  and where  $R' = \tan\alpha$ . The derivatives of the functions  $F_1$  and  $F_2$  with respect to  $Z$  are

$$F_1'(t) = -T' - \tau' + \exp\left(-\frac{t-T}{\tau}\right) \left(T' + \tau' + \frac{t-T}{\tau}\tau'\right) \quad (14)$$

$$F_2'(t) = 2F_1'(t) + T' + \frac{\tau'}{2} - \exp\left(-2\frac{t-T}{\tau}\right) \left(T' + \frac{\tau'}{2} + \frac{t-T}{\tau}\tau'\right) \quad (15)$$

The case of instantaneous acceleration along a straight collapse path corresponds to the classical P-E-R theory, for which the collapse conditions are

$$r_c = R - V_0 \cos(\alpha + \delta_0)(t_c - T) \quad (16)$$

$$z_c = Z + V_0 \sin(\alpha + \delta_0)(t_c - T) \quad (17)$$

For the general case of  $\alpha$  not a constant, the collapse angle is given by eq. (11) with

$$\frac{\partial r}{\partial Z} = R' + \cos(\alpha + \delta_0)[V_0 T' - V_0'(t - T)] + V_0 \sin(\alpha + \delta_0)(\alpha' + \delta_0')(t - T) \quad (18)$$

$$\frac{\partial z}{\partial Z} = 1 - \sin(\alpha + \delta_0)[V_0 T' - V_0'(t - T)] + V_0 \cos(\alpha + \delta_0)(\alpha' + \delta_0')(t - T) \quad (19)$$

To isolate the effect of collapse-path curvature, we consider also the in-between case of an exponential velocity history, eq. (2), but with a straight collapse path,  $\delta(t) = \delta_0$ . Then the collapse conditions are

$$r_c = R - V_0 \cos(\alpha + \delta_0)F_1(t_c) \quad (20)$$

$$z_c = Z + V_0 \sin(\alpha + \delta_0)F_1(t_c) \quad (21)$$

and the collapse angle is again given by eq. (11) with now

$$\frac{\partial r}{\partial Z} = R' - \cos(\alpha + \delta_0)(V_0'F_1 + V_0F_1') + V_0 \sin(\alpha + \delta_0)(\alpha' + \delta_0')F_1 \quad (22)$$

$$\frac{\partial z}{\partial Z} = 1 + \sin(\alpha + \delta_0)(V_0'F_1 + V_0F_1') + V_0 \cos(\alpha + \delta_0)(\alpha' + \delta_0')F_1 \quad (23)$$

in which  $F_1$  and its derivative are again given by eqs. (9) and (14).

To examine the behavior of the collapse path, a CTH computation was performed for a  $44^\circ$ -apex-angle conical copper-lined shaped charge. The original charge configuration is shown in Fig. 3, with the partially collapsed liner, beginning to form the jet, superimposed. The numbered points in the liner are Lagrangian tracer particles, which move with the material within which they are initially located. The computed collapse paths for these points, shown in Fig. 4, are not very curved. (The curvature at the bottom of each path is due not to liner acceleration but to the jet-formation process.)

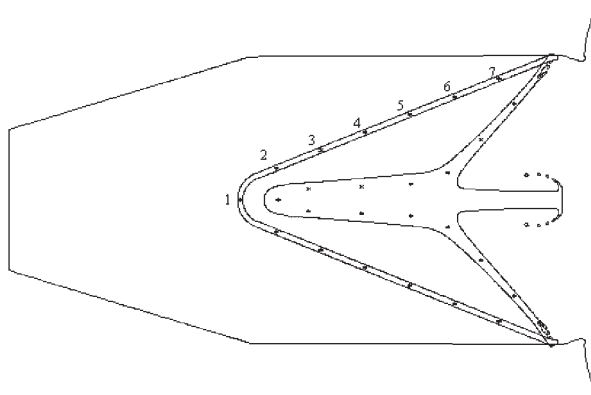

Figure 3. CTH hydrocode computation of shaped-charge liner collapse.

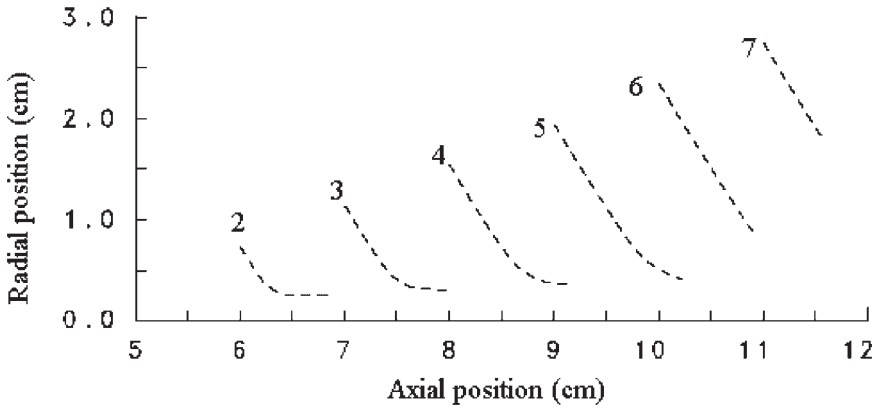

Figure 4. Collapse paths of liner particles computed by CTH code.

Collapse paths for selected points (#3 and #4 of Figs. 3 and 4) computed using the above equations are compared with the CTH computations in Figs. 5 and 6. These show only slight curvature in the paths. The reason for this is that, early on, when the projection angle is still small, the velocity is also small, so the displacement in the direction of small projection angle (i.e., along the original normal to the liner) is also small. Most of the displacement occurs when the liner has more fully accelerated and has thus achieved a greater fraction of its final projection angle.

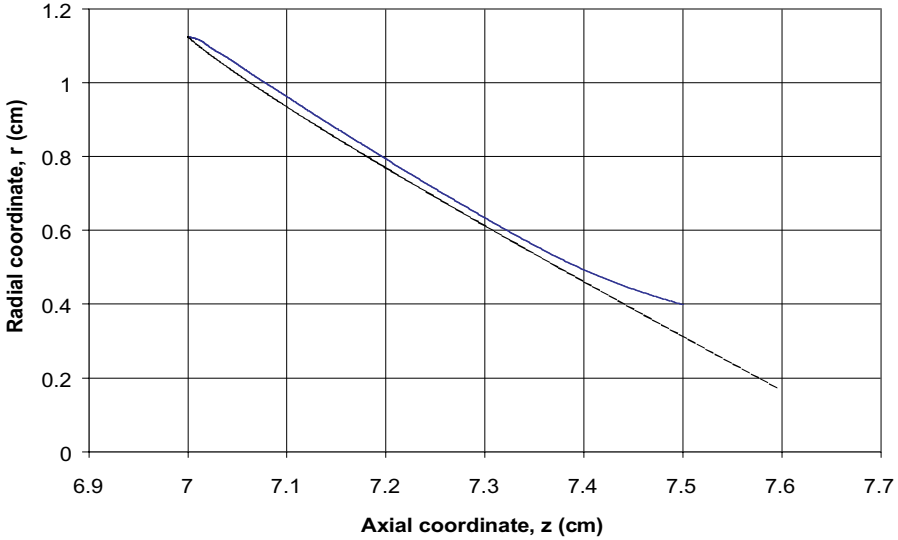

Figure 5. Collapse paths for liner point #3 computed by CTH (upper curve) and by present formulas (lower curve).

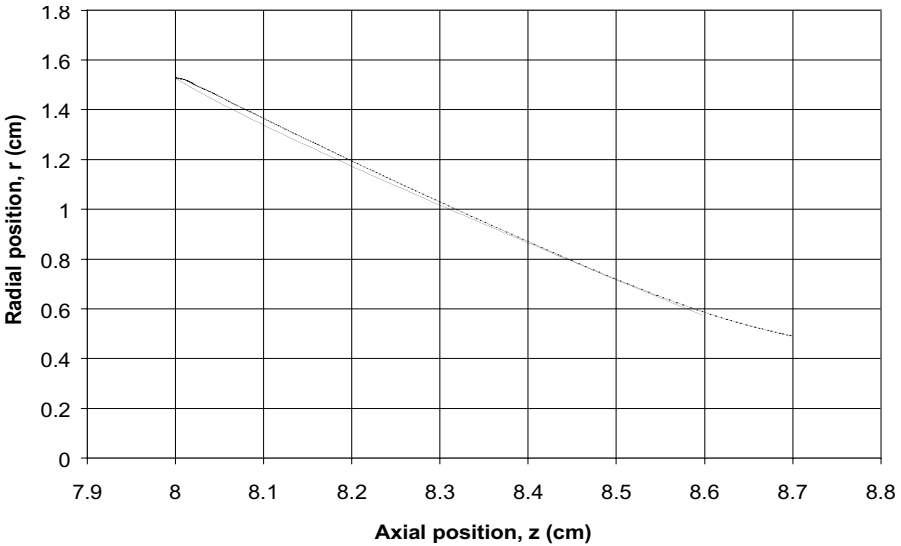

Figure 6. Collapse paths for liner point #4 computed by CTH (upper curve) and by present formulas (lower curve).

The several sets of collapse formulas were programmed into the analytical shaped-charge code DESC [7,8]. DESC was then exercised to predict the jet formation of the above shaped charge, using the various sets of formulas. The results are compared in Fig. 7,

which is a plot of jet velocity versus initial position in the liner. The three curves, corresponding to the P-E-R theory (instantaneous acceleration along a straight path) exponential acceleration along straight and curved paths, are almost identical except for the left end. The P-E-R theory predicts a significantly higher jet tip velocity (8.5 km/s) than the exponential-acceleration models (both 7.7 km/s). The curved-path model predicts that the collapse point will be slightly forward and  $\beta$  will be slightly smaller compared with the prediction of the classical P-E-R theory based on a straight collapse path.

## CONCLUSIONS

Collapse conditions for a shaped charge liner with an assumed exponential acceleration history and curved and straight collapse paths are derived. Hydrocode computations and computed results show that the degree of curvature is slight. Calculations of shaped charge jet properties based on curved or straight collapse paths using an exponential velocity history do not differ to a significant degree. Thus, the assumption of a straight collapse path introduces little error into predicted jet properties.

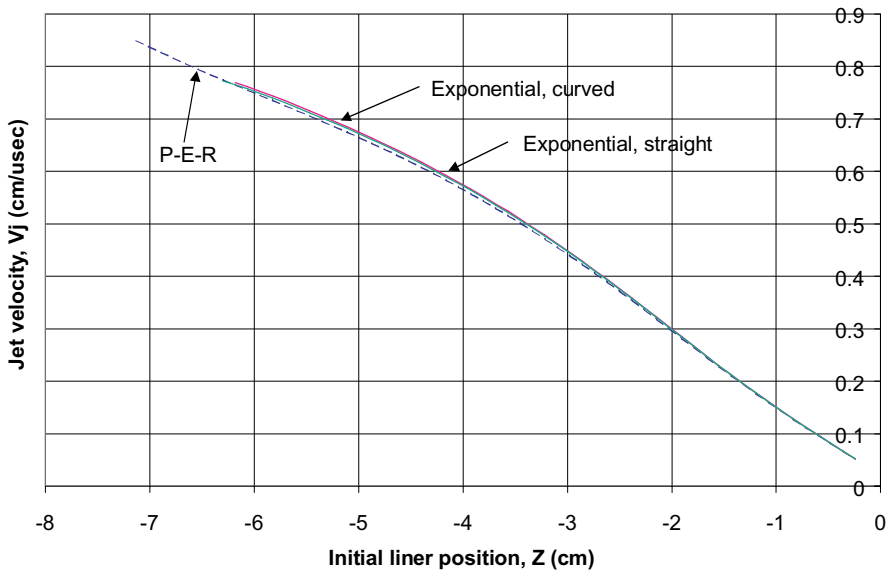

Figure 7. Predictions of jet-velocity distributions using the various collapse formulas computed using the DESC code.

## REFERENCES

1. E. Pugh, R. Eichelberger, and N. Rostoker, "Theory of Jet Formation by Charges with Lined Conical Cavities," *J. Appl. Phys.*, 23(5), 1952
2. R.J. Eichelberger, "Re-Examination of the Non-Steady Theory of Jet Formation by Lined Cavity Charges," *J. Appl. Phys.*, 26(4), 1955
3. G. Randers-Pehrson, "An Improved Equation for Calculating Fragment Projection Angle," *Proc. 2nd ISB*, 1976
4. P.C. Chou, J. Carleone, W.J. Flis, R.D. Ciccarelli, and E. Hirsch, "Improved Formulas for Velocity, Acceleration, and Projection Angle of Explosively Driven Liners," *Proc. 6th ISB*, 1981
5. W.J. Flis, "A Lagrangian Approach to Modeling the Acceleration of Metal by Explosives," *17th South-eastern Conf. Theor. Appl. Mech.*, Hot Springs, AR, 10–12 April 1994
6. L.A. Behrmann, "Calculation of Shaped Charge Jets Using Engineering Approximations and Finite Difference Computer Codes," AFATL-TR-72-160, Sept. 1973
7. J. Carleone, P.C. Chou, and C.A. Tanzio, "User's Manual for DESC-1, a One-Dimensional Computer Code to Model Shaped Charge Liner Collapse, Jet Formation, and Jet Properties," Dyna East Corp., DE-TR-75-4, Dec. 1975
8. W.J. Flis and C.M. Forsyth, "User's Manual for DESC-4, a One-Dimensional Computer Code for Shaped-Charge Analysis," Dyna East Corp., DE-TR-86-03, April 1986